

Operating and Maintenance Manual

Installation of

**The ECLIPSE #9800**

**&**

**The ECLIPSE #9800WC**

**The John C. Kupferle Foundry Company**

2511 North 9<sup>th</sup> Street  
St. Louis, Missouri  
63102, USA

Tel: 1-800-231-3990

Tel: 314-231-8738

Fax: 314-231-2820

Disclaimer: While this document is complete, comprehensive, and accurate to the best of Kupferle's knowledge, this document is subject to change and is for general information purposes only.

C:\Documents and Settings\robertg\Local Settings\Temporary Internet  
Files\Content.Outlook\VGDK721\9800 9800WC Operating and Maintenance Manual\_Rev0 (2).doc

# Index

Cover Page .....	1
Index .....	2
Description .....	3
Installation .....	5
Operation .....	6
Programming the Controller .....	7
Maintenance .....	9
Parts Replacement .....	10
Appendix #9800.....	11
Appendix #9800WC .....	12

# Description

1. The hydrant is a permanently installed flushing device intended to maintain high water quality by purging the older water from main water lines.

1.1. Cold Climate Equipment Number #9800

1.2. Warm Climate Equipment Number #9800WC

2. General Description

2.1. The **9800** automatic flushing hydrant has a 2” brass F.I.P. inlet which leads vertically into a 2” automatic flushing valve. The valve controls the flow of water through the hydrant and its diaphragm with the extension and retraction of a DC latching solenoid. All operating parts of the unit can be serviced or replaced without digging up or disturbing the supply line connection. The hydrant can be easily maintained or serviced above ground after the stainless steel access plate is removed, via removal from the water line, via an O-ring connector located under the valve. The valve has a 150 psi rating and is physically located below grade to protect against freezing. The entire unit is contained in a UV-Resistant enclosure with a removable locking cover.

NOTE: Refer to Appendix page 11 for a typical cut sheet.

2.2. The **9800WC** automatic flushing hydrant has a 2” brass M.I.P. inlet which leads vertically to the bottom of a 2” automatic flushing valve. The valve controls the flow of water through the hydrant and its diaphragm with the extension and retraction of a DC latching solenoid. All operating parts of the unit can be serviced or replaced without digging up or disturbing the supply line connection. The valve has a 150 psi rating and is physically located above grade inside of the enclosure allowing for easy service, and if desired removal via a quick disconnect. The entire unit is contained in a UV-Resistant enclosure with a removable locking cover.

NOTE: Refer to Appendix page 12 for a typical cut sheet.

3. The digital controller has nine possible flushing intervals per day. The length of a flush can be set for any amount of time ranging from 1 minute up to 4 hours. Refer to the Programming the Controller section (Pages 7-8) for how to set the controller parameters. The controller uses a standard 9-volt battery to pulse the solenoid valve and operate the controller. It is recommended that the battery be replaced every 500 flushes or once a year. Use the Battery Status icon on the controller screen to gauge the remaining life of the battery. An index of symbols encountered on the controller screen can be found on the reverse side of the controller.

#### 4. Key Description

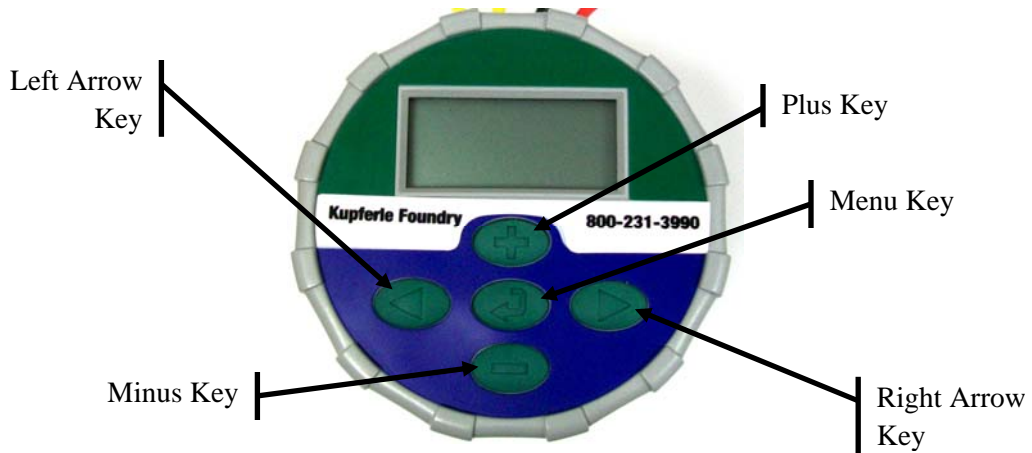

#### 5. Icon Description

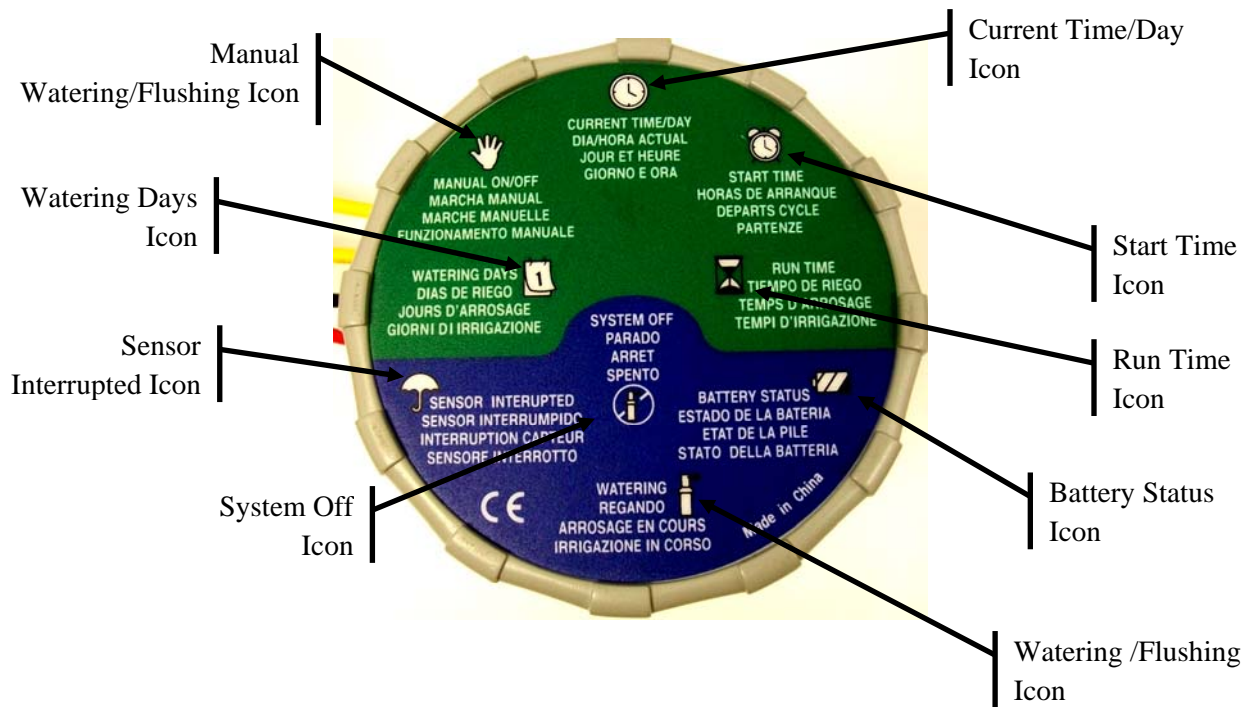

# Installation

1. The supply lines must be flushed free of any rock, gravel, or other debris before connecting the hydrant or installing any new or replacement parts.

9800

9800WC



Insert installed 9800WC photo here.

# Operation

## 1) General Description

When the time of day reaches a programmed time the controller will retract the solenoid valve, allowing water to travel through the 2" automatic flushing valve. After the programmed length of time has elapsed the controller will extend the solenoid valve, causing the diaphragm to close via the water pressure.

Water exits the unit through direct discharge and discharges to a separate drain system.

## 2) Performing a Manual Blow-Off / Test

The hydrant allows the user to perform manual blow-offs, a.k.a. manual tests, by temporarily overriding the timing functionality of the controller.

- a) Push the menu key until the current time is displayed on the Main Menu.

NOTE: The Main menu also shows the battery life remaining.

- b) Press and hold the right arrow key. The Manual Flushing icon will appear in the lower left of the screen.
- c) Use the plus or minus keys to adjust the flushing time between 1 minute and 4 hours.
- d) Once the keys are released, the controller will begin a 10 second countdown to start flushing. The Flushing icon will flash on the right side of the screen when flushing is in progress.

- e) To stop manual flushing, press the menu key until the System Off icon flashes on the left side of screen. After 4 seconds, "OFF" will appear on the display and the device will stop flushing.

**NOTE:** Leaving the controller to rest on the "OFF" screen shown above will put the controller in sleep/off mode preventing the controller from performing any programmed flushes. To continue with the scheduled flushing, press the menu key until the Main Menu is displayed, as seen to the right. Resting at this menu will allow the controller to perform the programmed flushing schedule.

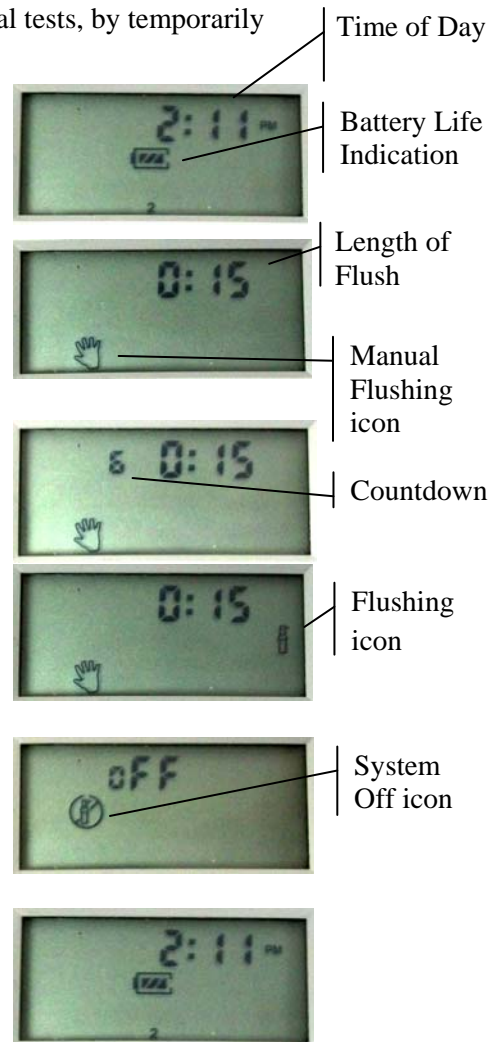

### 3) Manual Sampling

The unit also has a double-valve, all brass sampling point.

## Programming the Controller

### Setting the Date and Time

1. Press the menu key until the Current Time/Day icon appears in the top left corner of the screen. The display will show the hour, the minute, the time notation, and the day of the week. The day of the week is the number at the bottom of the screen. (1=Sun, 2=Mon, 3=Tues, etc)
2. Use the arrow keys to select the value to modify. Use the plus or minus keys to modify the selected value. Choices for time notation are AM, PM, and 24 hour.

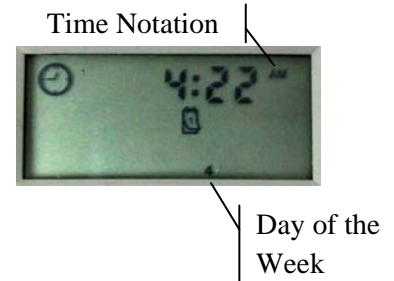

Kupferle recommends using the AM and PM time sets.

3. Navigating away from this screen will set the Current Time/Day.

### Setting Flushing Times

1. Press the menu key until the Start Times icon appears on the left side of the screen. The display will show the hour, the minute, and the Flush Time Number. The Flush Time Number is displayed to the left of the hour.
2. Use the arrow keys to select the Flush Time Number in which it is desired to modify the time. Use the plus/minus keys to change the time at which the unit will begin flushing. The "start time" will increase/decrease in 5 minute intervals.
3. To disable a Flush Time, select the desired Flush Time Number and set its time to OFF. OFF is found between 11:55 PM and 12:00 AM. When all Flush Times are set to OFF, then the unit's automatic flushing is off.
4. Navigating away from this screen will set the flush times.

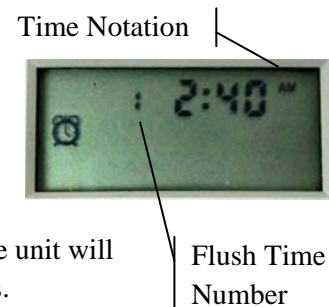

### Setting the Run Time (Length of Flushing)

1. Press the menu key until the Run Time icon appears in the bottom left corner of the screen.
2. Use the plus or minus keys to set the Run Time. Run Time can be scheduled from 1 minute up to 4 hours.
3. Navigating away from this screen will set the Run Time.



### Setting the Days to Flush

1. Press the menu key until the Watering Days icon appears in the upper left of the screen. The screen will display the days of the week at the bottom of the screen and indicate which days are set to be watered on and which days will not be watered. (1=Sun, 2=Mon,

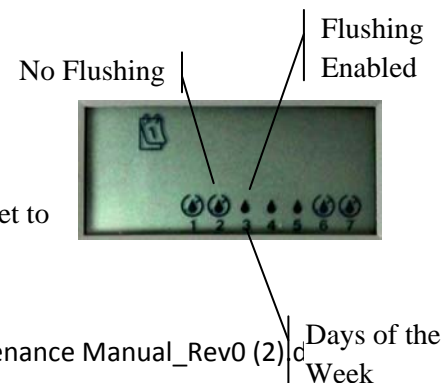

C:\Documents and Settings\robertg\Local Settings\Temporary Internet Files\Content.Outlook\VGDHK721\9800 9800WC Operating and Maintenance Manual\_Rev0 (2)

3=Tues, etc)

2. Use the arrow keys to select the desired day of the week. Use the plus or minus keys to activate or deactivate the flushing for the selected day. Once plus or minus is pushed, the cursor will advance to the next day.

### Selecting Interval Flushing

1. Press the menu key until the Watering Days icon in the upper left of the screen. The screen will display the days of the week at the bottom of the screen and indicate which days are set to be watered on and which days will not be watered.
2. Press the left arrow once when day 1 is selected, or press the right arrow once when day 7 is selected. The Interval Watering icon will appear on the display.
3. Press the plus or minus key to set the number of days between flushes. The flushing device will flush at the next Start Time and then again at the interval selected.

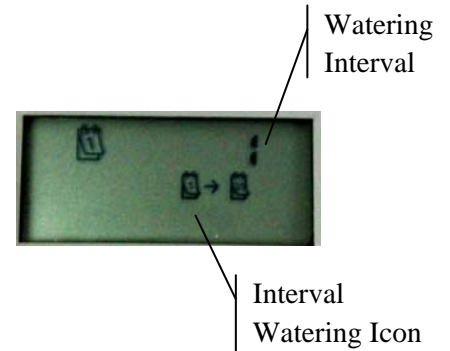

**NOTE: Kupferle does not recommend using the interval flushing option.**

# Maintenance

**NOTE: The water supply must be turned off before maintenance can be performed, typically via the valve box leading to the hydrant.**

## Removing the 2" Valve

### Cold Climate:

1. Remove lid from unit.
2. Move clasps to remove small plate.
3. Unbolt the two bolts to remove large access plate. Removal is accomplished by actually lifting the hydrant from the base.
4. Remove the pipe from the hydrant. All operating parts will then come up with the male o-ring connector plug.

### Warm Climate:

1. Remove lid from unit.
2. Unscrew the solenoid to relieve pressure from the valve.
3. Use the quick disconnect to separate the valve from the rest of the hydrant. All operating parts will then come up with the female disconnect.

## Troubleshooting the Controller

1. Turn off the Main Water Supply.
2. Unthread the solenoid from the valve to remove the controller from the unit.
3. Run a manual blow-off or test as described previously in #2 of the Operation section on Page 6.
4. If the solenoid audibly clicks and visibly retracts and if the controller is performing correctly, then the controller and solenoid are both in good working condition. The valve and diaphragm need to be checked for debris and/or damage; see below.

NOTE: Please make sure that the solenoid is firmly threaded into the valve. Overthreading or underthreading the solenoid may cause water flow issues.

## Cleaning and Inspecting the Valve and Diaphragm

1. Turn off the main water supply to the hydrant, if not already done so. Remove the 12 bolts from the valve.
2. Retrieve the diaphragm from within the unit. Do **NOT** remove the small spring from the bottom of the diaphragm.

3. Remove any and all debris from inside the valve. If desired, clean each piece with running water to remove smaller debris on the diaphragm or inside the unit. Inspect the diaphragm for any damage.
4. Inspect the plastic casing of the valve. “Hang nails” may be gently filed down.
5. Reassemble the valve and replace it on the unit. Turn the main water supply on. Test the unit.

## **Parts Replacement**

### ***Replacing the Battery***

1. Hold one side of the controller in each hand. Twist the controller to open the battery compartment.
2. Insert a new 9 volt alkaline battery into the battery holder.
3. Ensure that the battery compartment is free from water. Thread the controller back together to create a good seal.

NOTE: It is recommended that the battery be replaced every 500 flushes or once a year. Use the Battery Status icon on the controller screen to gauge the remaining life of the battery.

### ***Ordering Replacement Parts***

Replacement parts may be ordered from any water works distributor. A list of distributors may be obtained by calling Kupferle Foundry Co. at 800-231-3990 or by visiting Kupferle’s website.

[www.hydrants.com/component/part-maintenance.html](http://www.hydrants.com/component/part-maintenance.html)

Parts lists are also available on Kupferle’s website.

# Appendix

## #9800 AUTOMATIC FLUSHING DEVICE

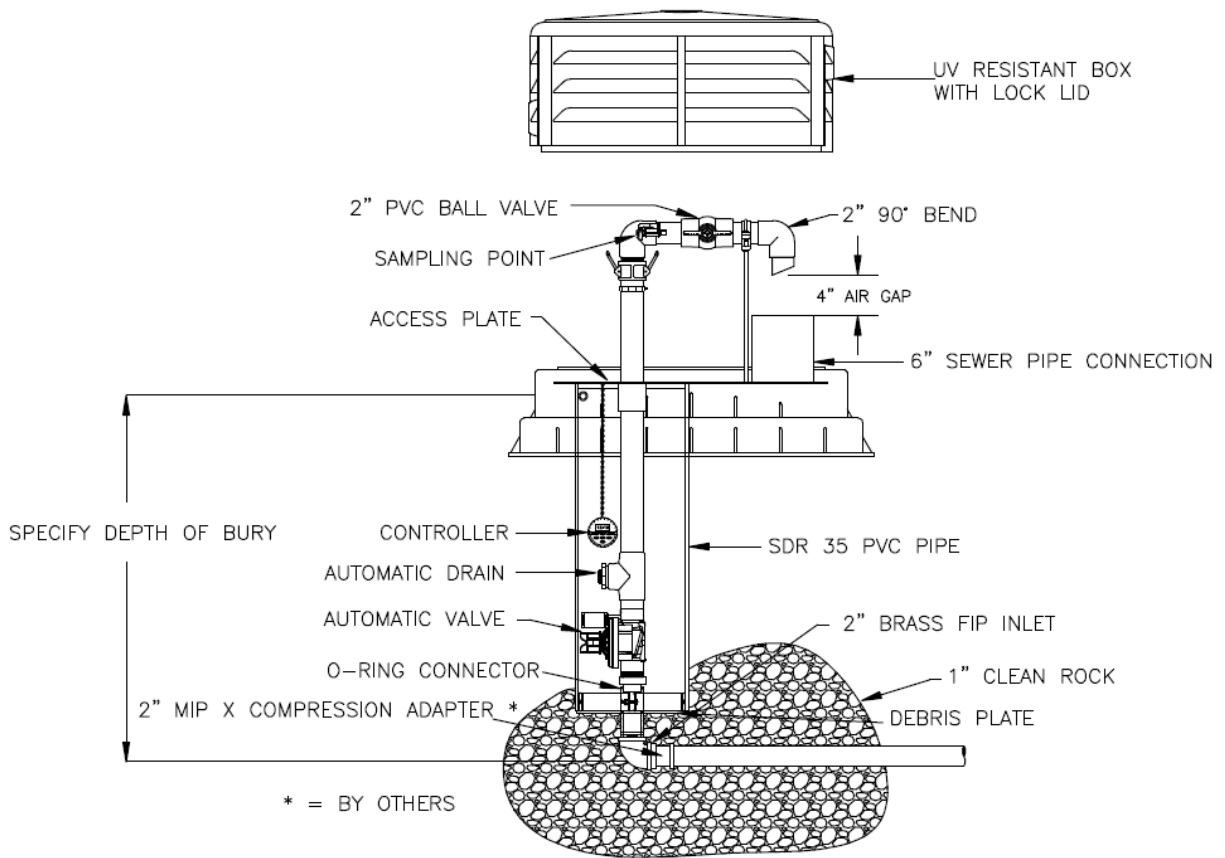

# #9800WC AUTOMATIC FLUSHING DEVICE

